



Thank You, Please Take A Moment

Thank You

For your decision to own this McIntosh MVS-3 Audio/Video Source Selector ranks you at the very top among discriminating music listeners. You now have "The Best." The McIntosh dedication to "Quality," is assurance that you will receive many years of enjoyment from this unit.

Please take a short time to read the information in this manual. We want you to be as familiar as possible with all the features and functions of your new McIntosh MVS3. This will ensure that you receive all the performance benefits this equipment can offer you, and that it will become a highly valued part of your Home Entertainment System.

Please Take A Moment

The serial number, purchase date and McIntosh dealer name are important to you for possible insurance claim or future service. The serial number is located on the rear panel of the equipment. The spaces below have been provided for you to record that information:

Serial Number:

**Please Take A Moment con't,
Customer Service**

Purchase Date:

Dealer Name:

Customer Service

If at any time you have questions about your MVS3 Audio/
Video Source Selector, please contact:

McIntosh Laboratory, Inc.
2 Chambers Street
Binghamton, New York 13903
Phone: 607-723-3512
FAX: 607-724-0549

Copyright 1997 © by McIntosh Laboratory, Inc.



Table of Contents

Table of Contents

Thank You and Please Take a Moment	2
Customer Service	3
Table of Contents	4
Safety Instructions	5
Introduction, Performance Features and Installation	10
How to Connect with a Surround Decoder	11
Front Panel Connections, Control, Display and Switch ...	14
How to Connect with a Control Center	15
How to Connect to a TV Antenna Input	18
How to Reassign Inputs	20
How to Operate	21
Specifications and Packing Instruction	23

NOTE: The MVS3 can be operated together with a McIntosh Control Center or Surround Decoder with a Power Amplifier. Please refer to the following listing of instructions as a guide:

For use with a McIntosh Surround Decoder



How to Connect	11
How to Reassign Inputs	20
How to Operate	21

For use with a McIntosh Control Center

How to Connect	15
How to Operate	21

IMPORTANT SAFETY
INSTRUCTIONS!

**PLEASE READ THEM BEFORE
OPERATING THIS EQUIPMENT.**

 **WARNING SHOCK HAZARD -
DO NOT OPEN.**
 **AVIS RISQUE DE CHOC -
NE PAS OUVRIR.**

CAUTION
RISK OF ELECTRIC SHOCK
DO NOT OPEN

ATTENTION
DANGER D'ELECTROCUTION
NE PAS OUVRIR

**NO USER-SERVICEABLE
PARTS INSIDE. REFER
SERVICING TO
QUALIFIED PERSONNEL**

General:

1. Read all the safety and operating instructions, contained in this owner's manual, before operating this equipment.
2. Retain this owner's manual for future reference about safety and operating instructions.



Safety Instructions con't

3. Adhere to all warnings and operating instructions.

4. Follow all operating and use instructions.

5. Warning: To reduce risk of fire or electrical shock, do not expose this equipment to rain or moisture. This unit is capable of producing high sound pressure levels. Continued exposure to high sound pressure levels can cause permanent hearing impairment or loss. User caution is advised and ear protection is recommended when playing at high volumes.

6. Caution: to prevent electrical shock do not use this (polarized) plug with an extension cord, receptacle or other outlet unless the blades can be fully inserted

to prevent blade exposure.

Attention: pour pevenir les chocs elecriques pas utiliser cette fiche polarisee avec un prolongateur, une prise de courant ou un autre sortie de courant, sauf si les lames peuvent etre inserees afond ans en laisser aucune partie a decouvert.

7. For added protection for this product during a lightning storm, or when it is left unattended and unused for long periods of time, unplug it from the wall outlet and disconnect the antenna or cable system. This will prevent damage to the product due to lightning or power line surges.

8. Do not use attachments not recommended in this

Safety Instructions con't

owner's manual as they may cause hazards.

Installation:

9. Locate the equipment for proper ventilation. For example, the equipment should not be placed on a bed, sofa, rug, or similar surface that may block ventilation openings; or, placed in a built-in installation, such as a bookcase or cabinet, that may impede the flow of air through the ventilation openings.
10. Locate the equipment away from heat sources such as radiators, heat registers, stoves, or other appliance (including amplifiers) that produce heat.
11. Mount the equipment in a wall or cabinet only as de-

scribed in this owner's manual

12. Do not use this equipment near water; for example, near a bathtub, washbowl, kitchen sink, laundry tub, in a wet basement or near a swimming pool, etc.
13. Do not place this product on an unstable cart, stand, tripod, bracket, or table. The equipment may fall, causing serious injury to a person, and serious damage to the product.

Connection:

14. Connect this equipment only to the type of AC power source as marked on the unit.
15. Route AC power cords so that they are not likely to be



Safety Instructions con't

walked on or pinched by items placed upon or against them, paying particular attention to cords at plugs, convenience receptacles, and the point where they exit from the instrument.

16. Do not defeat the inherent design features of the polarized plug. Non-polarized line cord adapters will defeat the safety provided by the polarized AC plug. If the plug should fail to fit, contact your electrician to replace your obsolete outlet. Do not defeat the safety purpose of the grounding-type plug.
17. Do not overload wall outlets, extension cords or integral convenience receptacles as this can result in a risk of fire or electric shock.

Care of Equipment:

18. Clean the instrument by dusting with a dry cloth. Unplug this equipment from the wall outlet and clean the panel with a cloth moistened with a window cleaner. Do not use liquid cleaners or aerosol cleaners.
19. Do not permit objects of any kind to be pushed and/or fall into the equipment through enclosure openings. Never spill liquids into the equipment through enclosure openings.
20. Unplug the power cord from the AC power outlet when left unused for a long period of time.

Safety Instructions con't

Repair of Equipment:

21. Unplug this equipment from the wall outlet and refer servicing to a qualified service personnel under the following conditions:
 - A. The AC power cord or the plug has been damaged,
 - B. Objects have fallen, or liquid has been spilled into the equipment,
 - C. The equipment has been exposed to rain or water,
 - D. The equipment does not operate normally by following the operating instructions contained within this owner's manual. Adjust only those controls that are covered by the operating instructions, as an improper adjustment of other controls may result in damage and will often require extensive work by a qualified technician to restore the product to its normal operation,
 - E. The equipment has been dropped or damaged in any way,
 - F. The equipment exhibits a distinct change in performance - this indicates a need for service.
22. Do not attempt to service beyond that described in the operating instructions. All other service should be referred to qualified service personnel.
23. When replacement parts are required, be sure the service technician has used replacement parts specified by McIntosh or have the same characteristics as the origi-



Safety Instructions con't, Introduction, Performance Features and Installation

nal part. Unauthorized substitutions may result in fire, electric shock, or other hazards.

24. Upon completion of any service or repairs to this product, ask the service technician to perform safety checks to determine that the product is in proper operating condition.

Introduction

The McIntosh MVS3 Audio/Video Source Selector provides you with the capability of selecting up to five different Audio/Video sources when used together with a McIntosh Control Center or Surround Decoder. It will also allow you to reassign the five inputs for specific sources.

Performance Features

- Selection up to five different Audio/Video Sources
- Data Control Connections, Remap Inputs
- S-Video, Composite Video and Audio Connections
- RF Modulator Output

Installation

The MVS3 can be placed upright on a table or shelf. Cool operation ensures the longest possible operating life for any electronic instrument. Do not install the MVS3 directly above a heat generating component such as a high powered amplifier.

How to Connect with a Surround Decoder

How to Connect with a Surround Decoder

1. Connect the MVS-3 power plug to an AC outlet.
2. Connect the MAC-3 DATA OUT to the MVS-3 DATA IN using a Data cable.
3. Connect a cable from the MVS-3 LV DATA OUTPUT to the LV player CONTROL (DATA) jack, from the MVS-3 LV AUDIO INPUTS to the player LV AUDIO OUT jacks and a Video cable (either S or Composite) from the MVS-3 LV VIDEO INPUT to the matching VIDEO OUT on the LV player.
4. Connect the MVS-3 VCR1 AUDIO/VIDEO INPUTS to the Audio/Video Outputs of the VCR1.
5. Connect a Video cable from the MVS-3 TV VIDEO INPUT to the Video Output of a Satellite Receiver.
6. Connect the MVS-3 CONTROL CENTER AUDIO OUTPUTS to the MAC-3 ANALOG INPUT.
7. Connect a Video cable from the MVS-3 MONITOR VIDEO OUTPUTS to the Video Input of a TV Monitor.

NOTES:

1. A Data cable consists of shielded wire with a 1/8



How to Connect with a Surround Decoder con't

inch mini phone plug, either stereo or mono, on each end. Connections are to the tip (+) and sleeve (-) of the plug. (McIntosh Part No. 170-202).

2. If the source component is non McIntosh, it can be controlled by adding a McIntosh RCT Translator to the system.

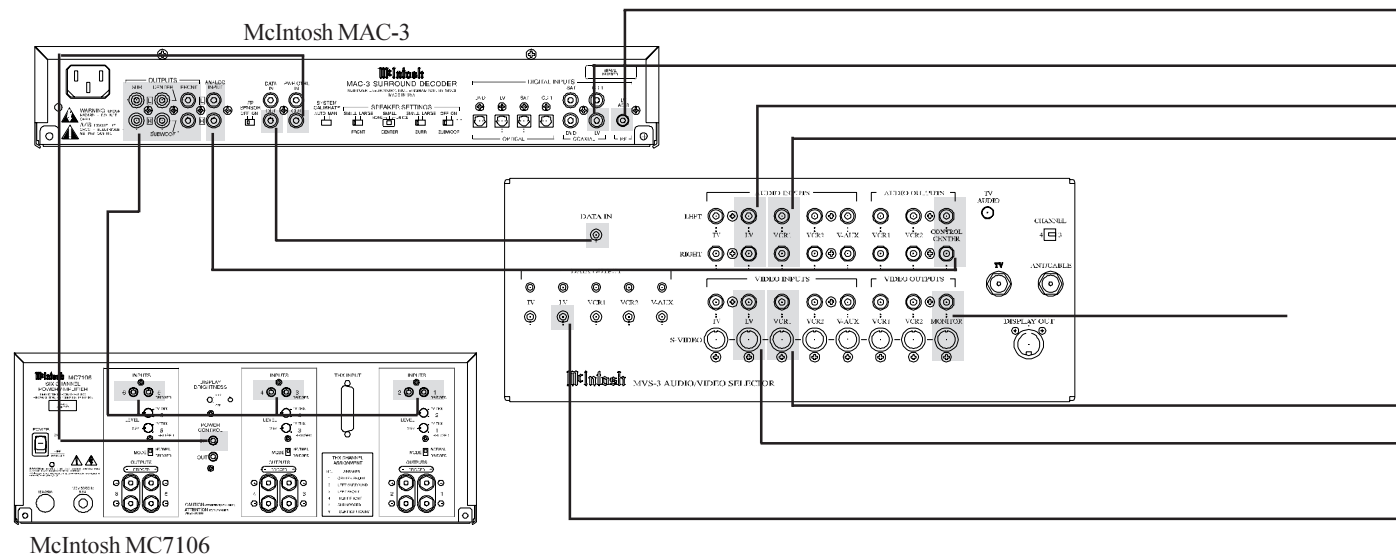

How to Connect with a Surround Decoder con't

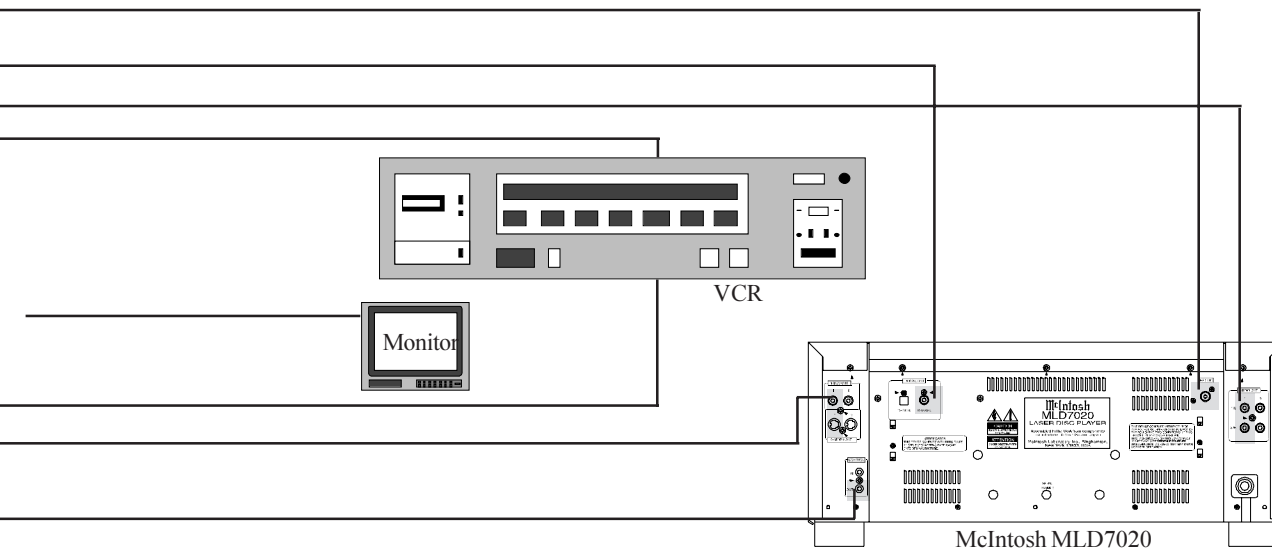

3. *The Video Input and Output connections must be either all Composite or all "S" Video, and cannot be mixed. The two video circuits are completely separate.*
4. *If you wish to use a Satellite receiver The MVS-3 TV VIDEO INPUT must be reassigned to SAT for this operating mode. Refer to "HOW TO REASSIGN MVS-3 INPUTS".*



Front Panel Connections, Control, Display and Switch

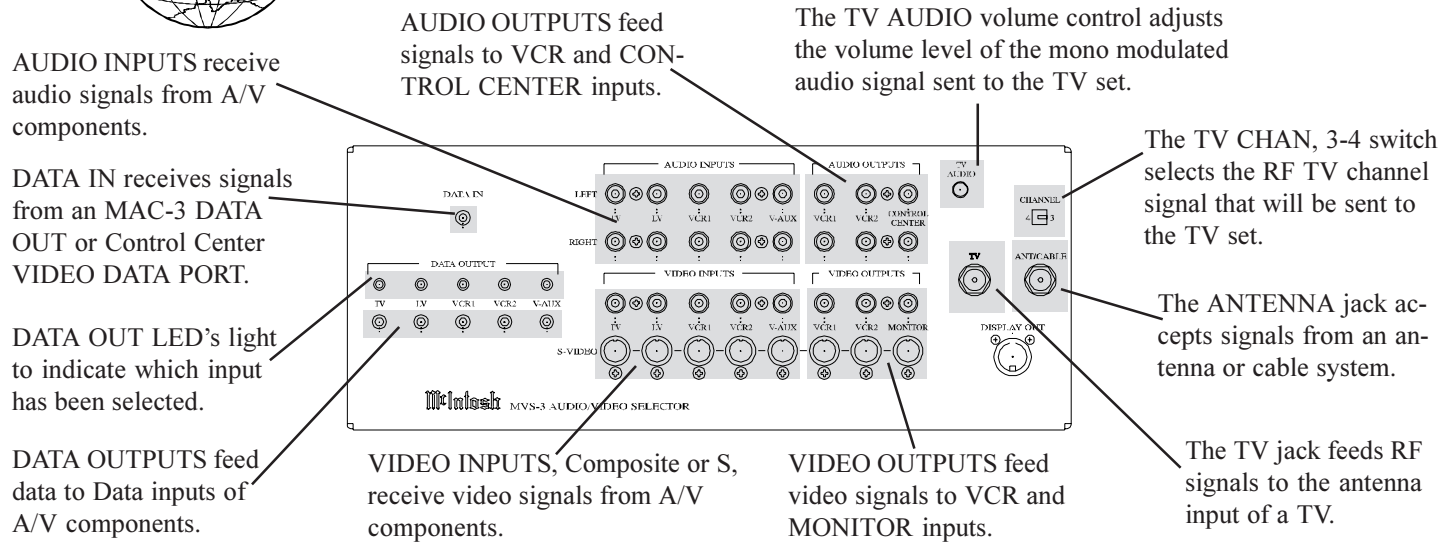

How to Connect with a Control Center

How to Connect with a Control Center

1. Connect the MVS-3 power plug to an AC outlet.
2. Connect the C38 VIDEO DATA OUT to the MVS-3 DATA IN using a Data cable.
3. Connect a cable from the MVS-3 LV DATA OUTPUT to the LV player DATA jack, from the MVS-3 LV AUDIO INPUTS to the player LV AUDIO OUT jacks and a Video cable (either S or Composite) from the MVS-3 LV VIDEO INPUT to the matching VIDEO OUT on the LV player.
4. Connect the MVS-3 VCR1 AUDIO/VIDEO INPUTS to the Audio/Video Outputs of the VCR1.
5. Connect a Video cable from the MVS-3 TV VIDEO INPUT to the Video Output of a Satellite Receiver.
6. Connect the MVS-3 CONTROL CENTER AUDIO OUTPUTS to the C38 VIDEO INPUT.
7. Connect a Video cable from the MVS-3 MONITOR VIDEO OUTPUTS to the Video Input of a TV Monitor.

NOTES:

1. A Data cable consists of shielded wire with a 1/8 inch mini phone plug, either stereo or mono, on each end. Connections are to the tip (+) and sleeve (-) of the plug. (McIntosh Part No. 170-202).



How to Connect with a Control Center con't

2. If the source component is non McIntosh, it can be controlled by adding a McIntosh RCT Translator to the system.
3. The Video Input and Output connections must be either all Composite or all "S" Video, and cannot be mixed. The two video circuits are completely separate.

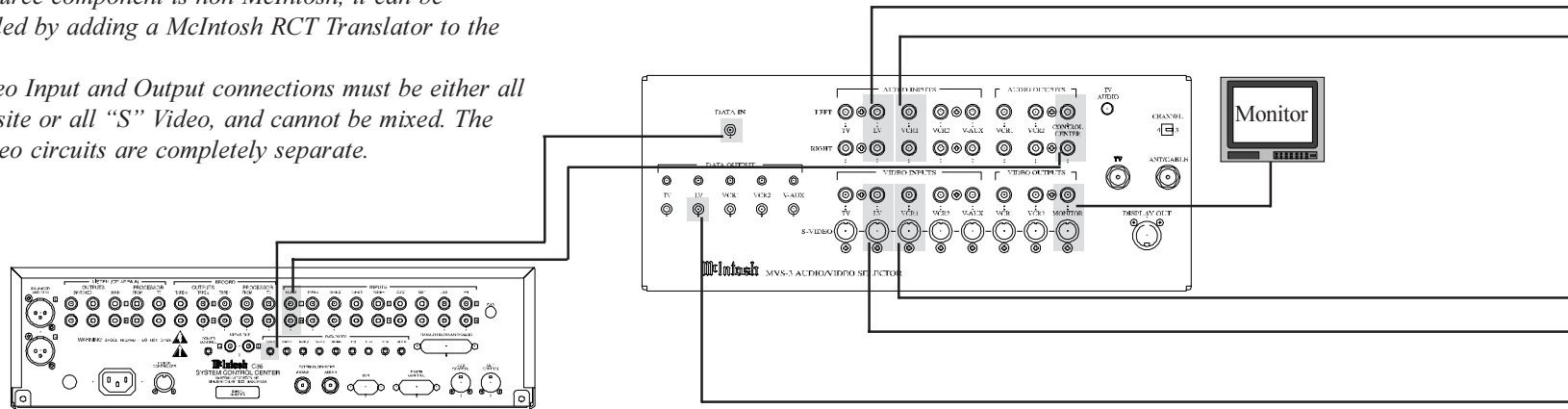

How to Connect with a Control Center con't

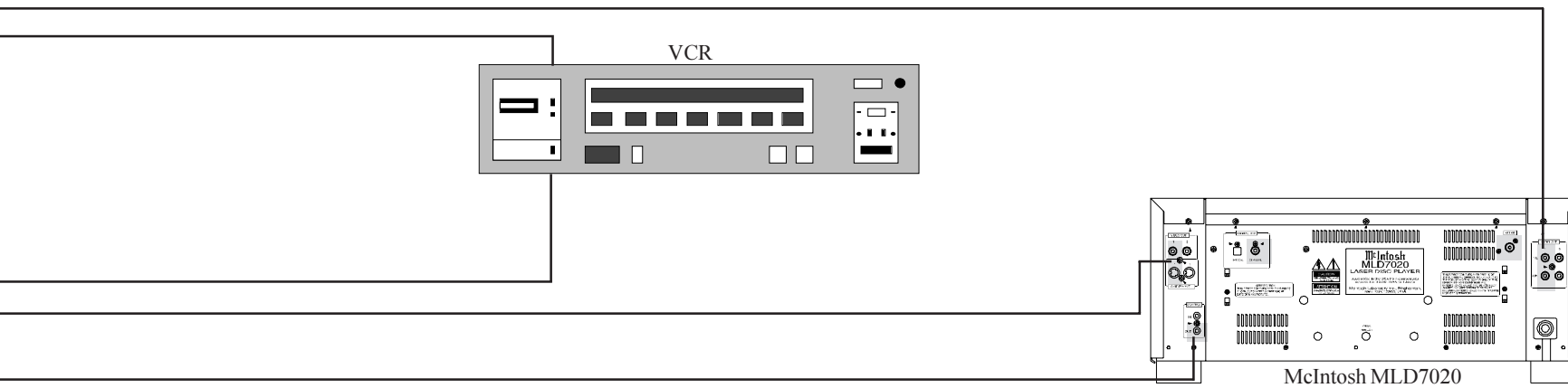



How to Connect to a TV Antenna Input

How to Connect to a TV Antenna Input

1. Remove the antenna cable from the TV antenna connector.
2. Connect a coaxial cable from the MVS-3, TV jack to the antenna input of the TV in place of the original antenna.
3. Reconnect the antenna lead that was on the TV to the MVS-3 antenna jack..
4. Select TV channel 3 or channel 4, depending on which channel of the TV set is to receive the MVS-3, RF modulated signal.
5. When the MVS-3 is on and operating, video and mono

audio from the selected A/V inputs will be sent to the TV set from the TV jack.

6. When the MVS-3 power is turned off, RF broadcast signals from the ANTENNA jack will be sent straight through to the TV from the TV jack.

NOTE:

1. *The MVS-3 must have its power cord connected to a switched AC outlet for this mode of operation since its power must be turned OFF for the ANTENNA - TV Straight Through function to occur.*
2. *The MVS-3 RF modulator sends only mono audio signals to the TV*

How to Connect to a TV Antenna Input con't

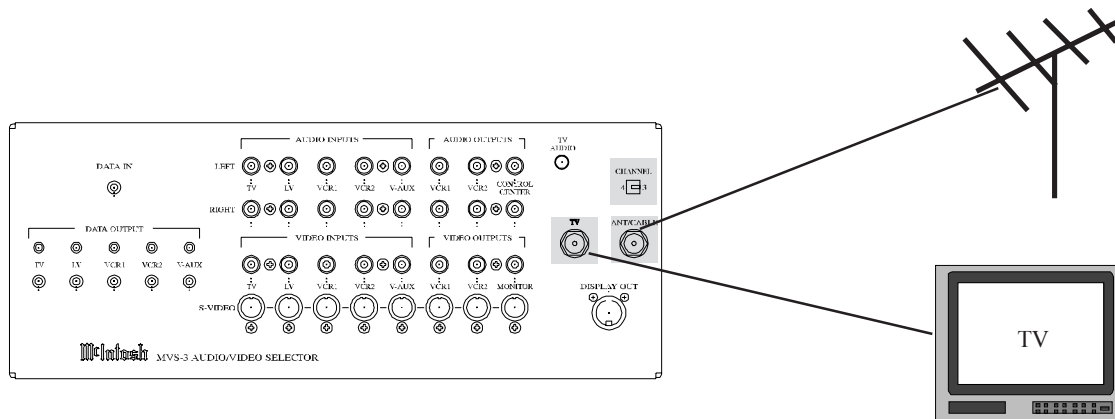



How to Reassign Inputs

How to Reassign Inputs

To enable the MVS-3 to switch Audio/Video Signals for the SAT input of the MAC-3, one of the MVS-3 Inputs must be reassigned, by using the HR130 Remote Control. The reassignment changes the MVS-3 so it considers a MAC-3 SAT selection the same as a TV (Input#1).

1. Aim the Remote Control toward the MAC-3 sensor and press the following push-buttons within 3 seconds between any two push-button presses.
 - A. Press 2539.
 - B. Press E (Enter).
 - C. Press Input 1.
 - D. Press SAT.

The TV (Input 1) DATA LED will flash once, and turn ON to indicate that the MVS-3 has accepted the reassignment. Reassign other inputs by following the above procedure.

NOTE: To cancel the MVS-3 input reassignments and return to the factory default settings, press the numbers 2539, enter and then the "0" (Zero) push-button on the HR130 Remote Control. Factory Default Inputs listed below:

<i>TV</i>	<i>Input No. 1</i>
<i>LV</i>	<i>Input No. 2</i>
<i>VCR 1</i>	<i>Input No. 3</i>
<i>VCR 2</i>	<i>Input No. 4</i>
<i>V-AUX</i>	<i>Input No. 5 (DVD input on the MAC-3)</i>

How to Operate

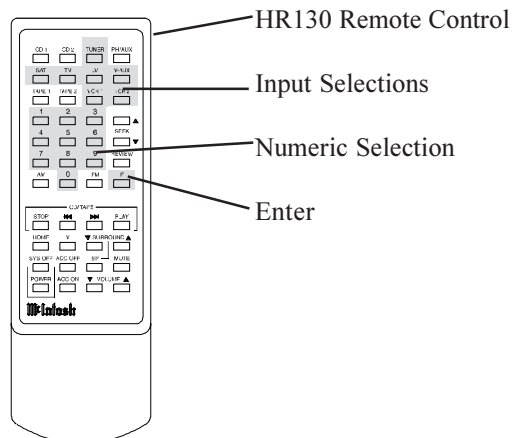

How to Operate

How to operate in a Surround System with the MAC-3
Select the desired Input program source with the MAC-3 Input switch or with the HR130 Remote Control. After selecting the desired program source, operate the source component according to its owner's manual instructions, and then refer to the MAC-3 Owner's manual for operating details.

How to operate with a Control Center

Select the desired input source with the Listen switch or the Remote Control. Operate the Control Center and associated



A/V components as directed by their respective owner's manuals.

How to use a Satellite receiver that has an analog output

The MAC-3 can be reassigned to accept Analog audio signals from a satellite receiver, when the SAT digital input is selected. Reassignment is performed with the HR130 Remote Control.

1. Manually rotate the MAC-3 INPUT selector to ANALOG.
2. Press the MAC-3 SURROUND push-button to ON.
3. Press and HOLD the SURROUND push-button until

the LED above the push-button starts to blink ON and OFF.

4. Using the HR130 Remote Control, press the SAT push-button. You will now hear audio from the satellite receiver being sent to the MAC-3 ANALOG input.

If you wish to temporarily go back to receiving digital PCM audio from the satellite receiver, MANUALLY rotate the MAC-3 INPUT selector to SAT.

Specifications and Packing Instructions

Specifications

Power Requirements

100 Volts, 50/60Hz at 20 watts.
110 Volts, 50/60Hz at 20 watts.
120 Volts, 50/60Hz at 20 watts.
220 Volts, 50/60Hz at 20 watts.
230 Volts, 50/60Hz at 20 watts.
240 Volts, 50/60Hz at 20 watts.

NOTE: Refer to the side of the MVS3 for the correct voltage

Dimensions

12 1/4 inches (31.2 cm) Wide, 4 3/4 inches (12.1 cm) High,
3 3/8 inches (8.6 cm) depth

Weight

5.5 pounds (2.5 Kg)

Packing Instructions

In the event it is necessary to repack the equipment for shipment, use the original shipping carton and packing material only if they are in good serviceable condition. If a shipping carton or packing material are needed, please call or write Customer Service Department of McIntosh Laboratory and order the following:

<u>Quantity</u>	<u>Part Number</u>	<u>Description</u>
1	033719	Shipping carton
1	033085	Bubble Pack

McIntosh[®]

McIntosh Laboratory, Inc.
2 Chambers Street
Binghamton, NY 13903

McIntosh Part No. 03990001